

FRANZ VIEGENER

N e r e a p l u s

i n s t a l l a t i o n



Installation

Nerea plus Faucets - Line 59L

CONGRATULATIONS !

This product has been subjected to stringent tests for its quality, performance and finish. We guarantee years of trouble free operation. We thank you for your choice and above all for the trust you are placing in us. This trust is what motivates us to improve every day.

Before connecting the faucet to the water supply, flush the tubing thoroughly to eliminate any residue.

Required installation tools.

(Not provided).

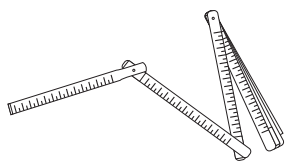

Ruler

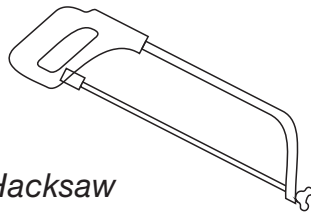

Hacksaw

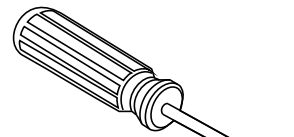

Phillips
Screwdriver

FV114/59L.0

To be used with
FV114C.BASE

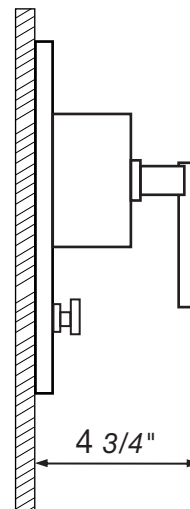
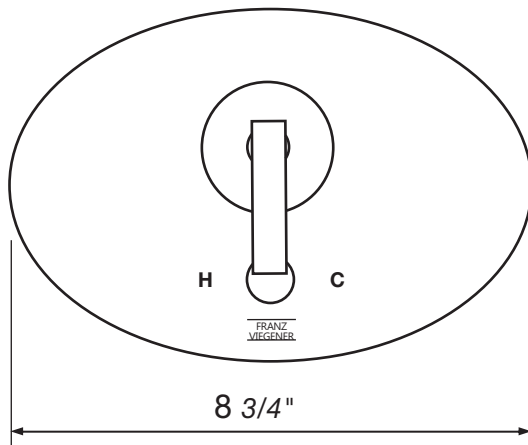
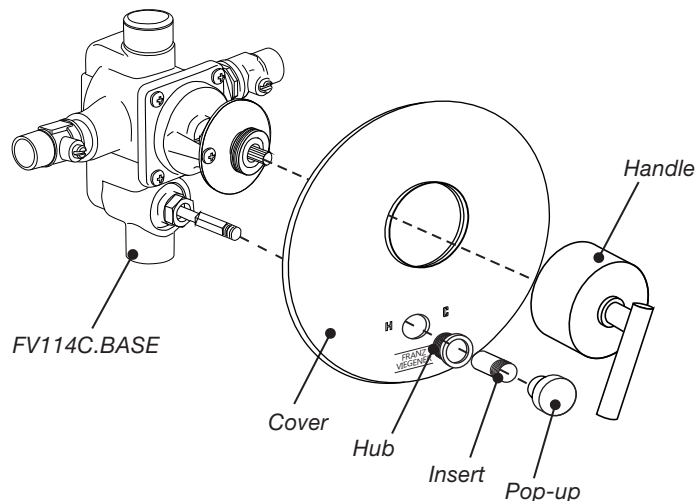

Remove rough-in cover

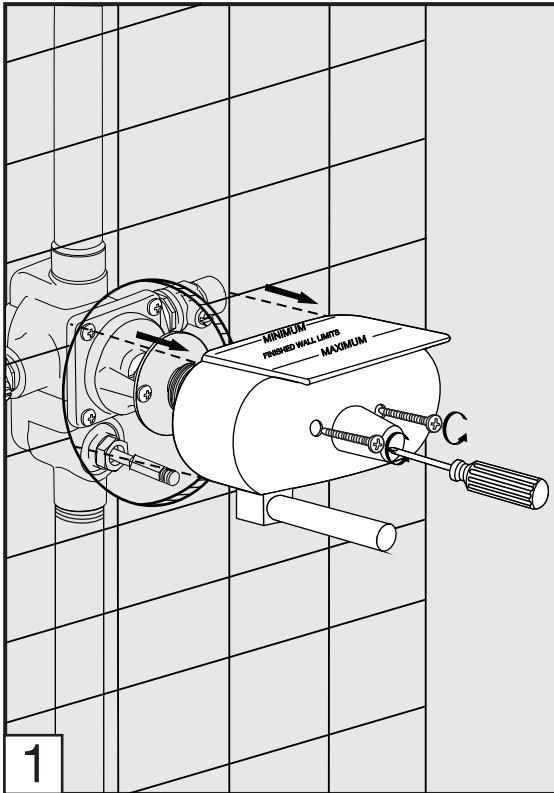

Install trim plate

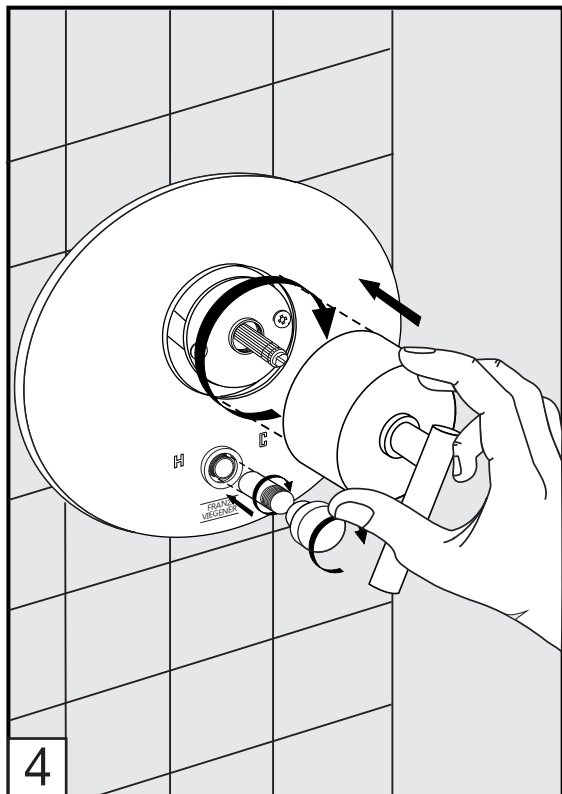
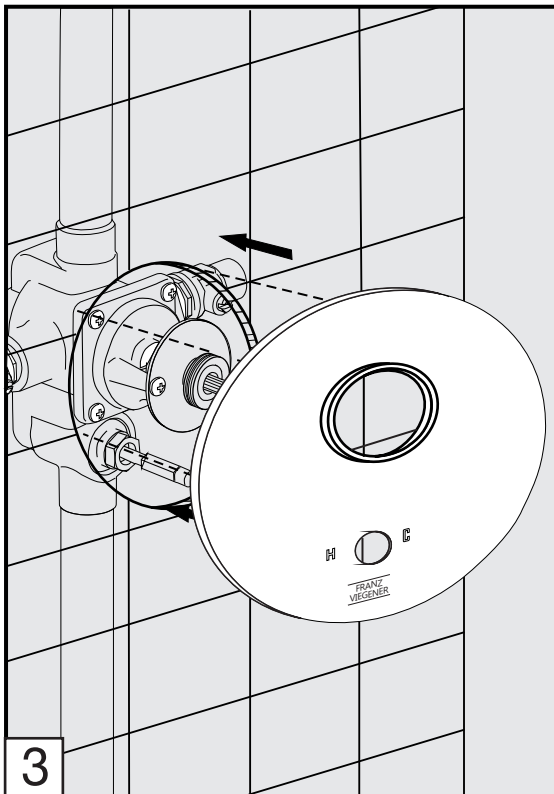
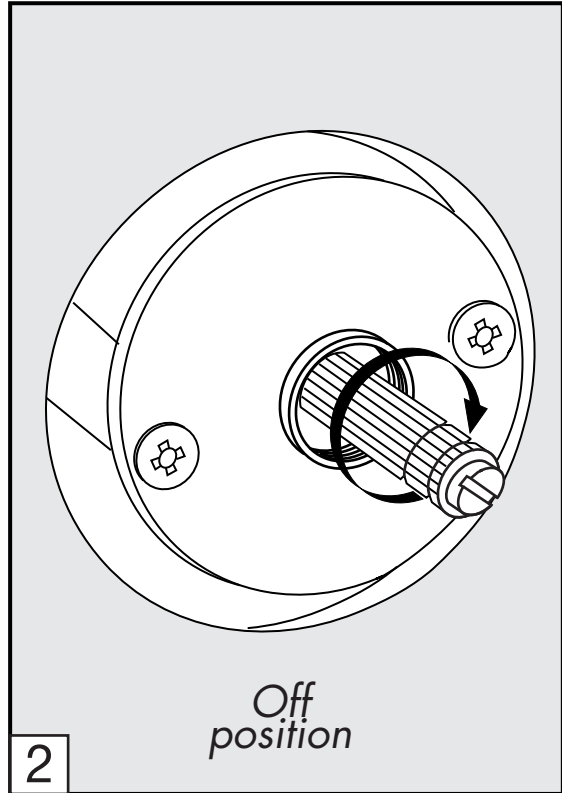

ADJUSTMENT

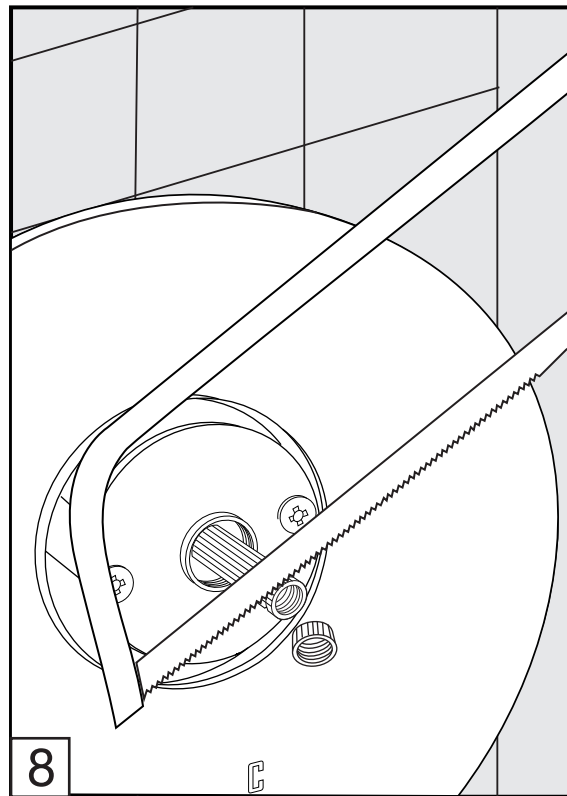
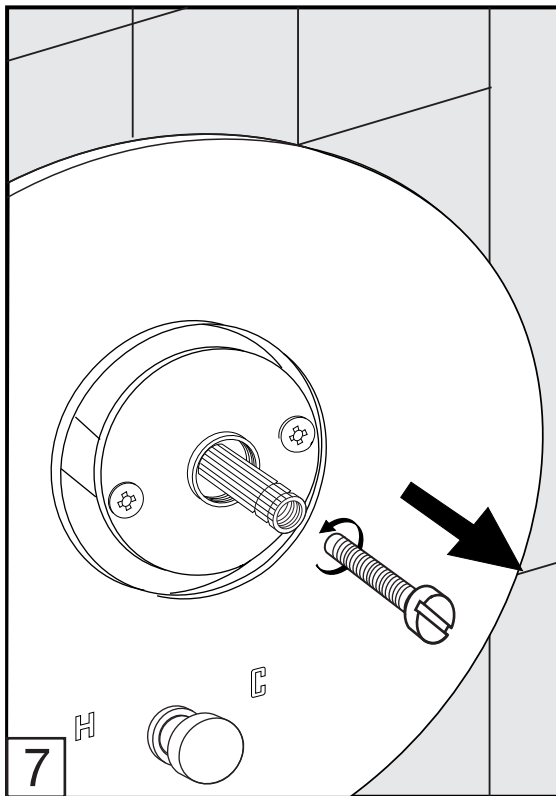
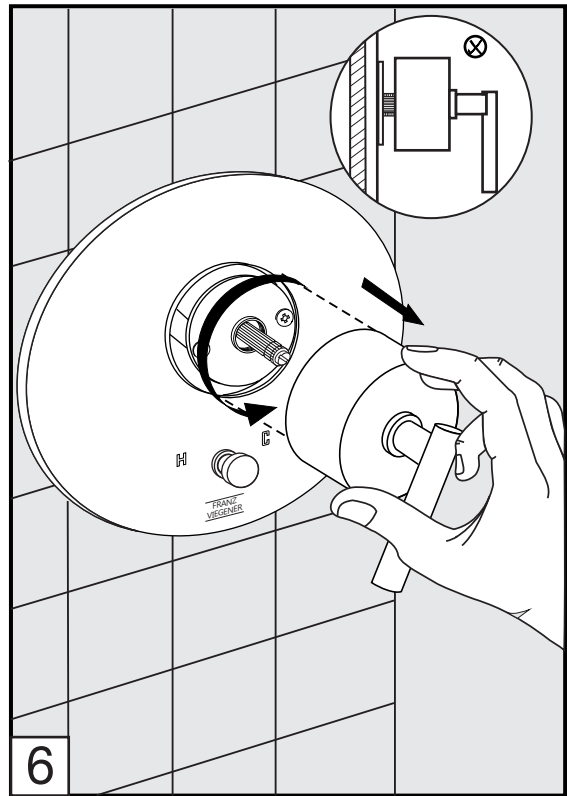
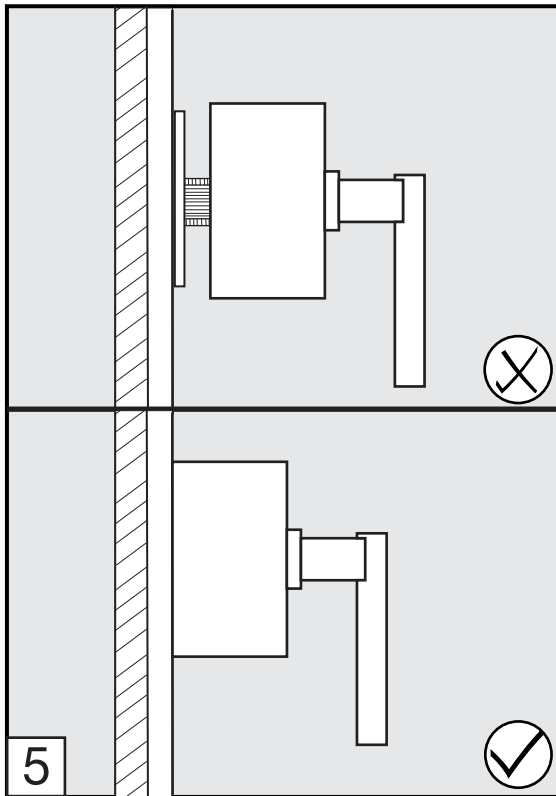

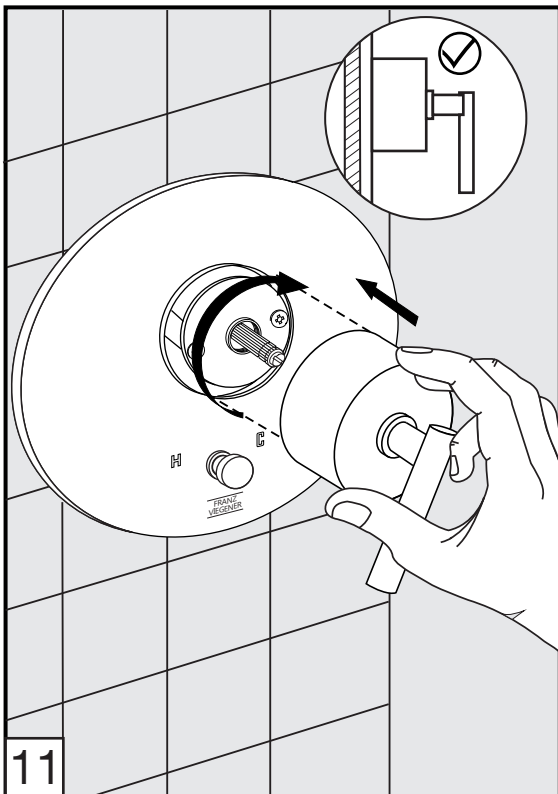
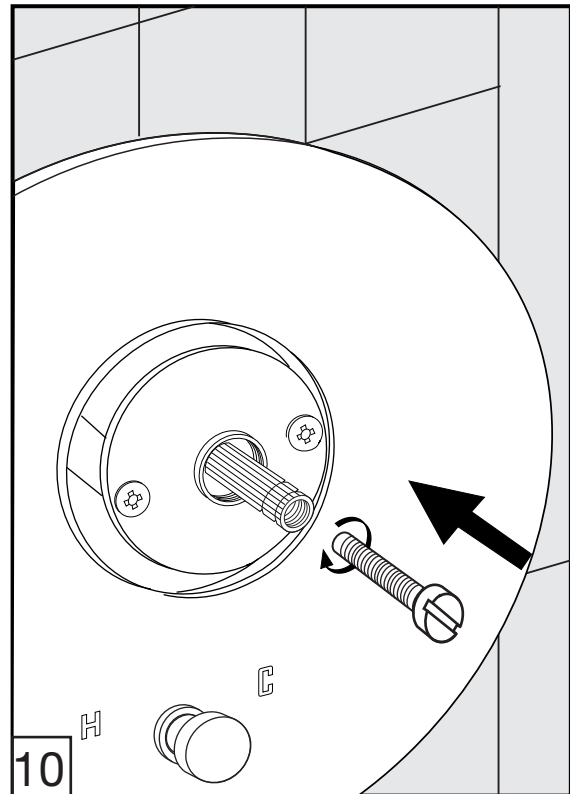
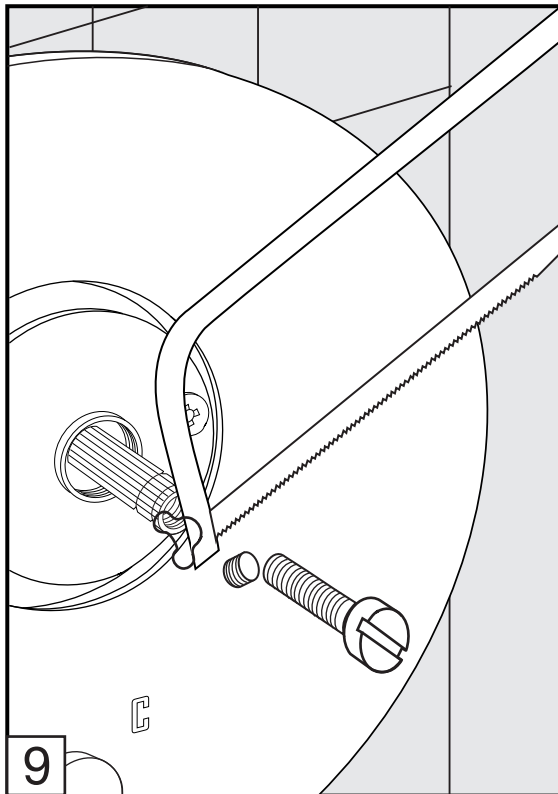

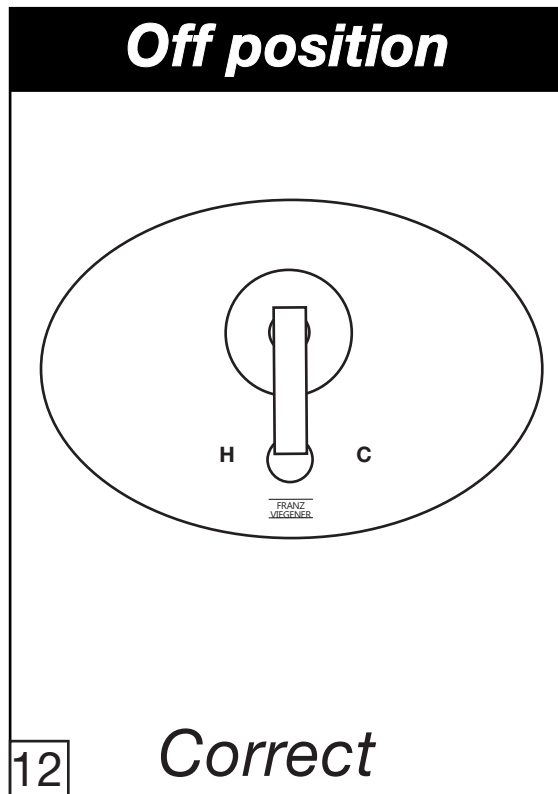

Cleaning and care instructions

It is recommended to wipe faucets dry with a soft cloth after use to avoid spots left by mineral deposits when water evaporates.

Avoid harsh and abrasive cleaners on all faucet surfaces.

Use only a soft damp cloth with mild liquid soap to clean the faucet surfaces of all finishes including coated polished brass, gold, pewter, etc.

Painted and plated surfaces alike, should be coated regularly with a thin protective film. Non-abrasive liquid car wax is recommended.

FRANZ VIEGENER.

a FV S.A. Company.

4000 Porett Drive • Gurnee Illinois 60031

Phone 847-244-1234

Fax 847-244-1259 • Web: www.fvamerica.com

FRANZ VIEGENER reserve the right to make revisions without notice in the design of faucets and bathrooms accessories or in packaging.

FOLFV114/59L.0 / Edition No 1 _ October, 2011