

Installation and maintenance/Instalación y mantenimiento

FV457/K5 - Soap dispenser/Dispenser de jabón.

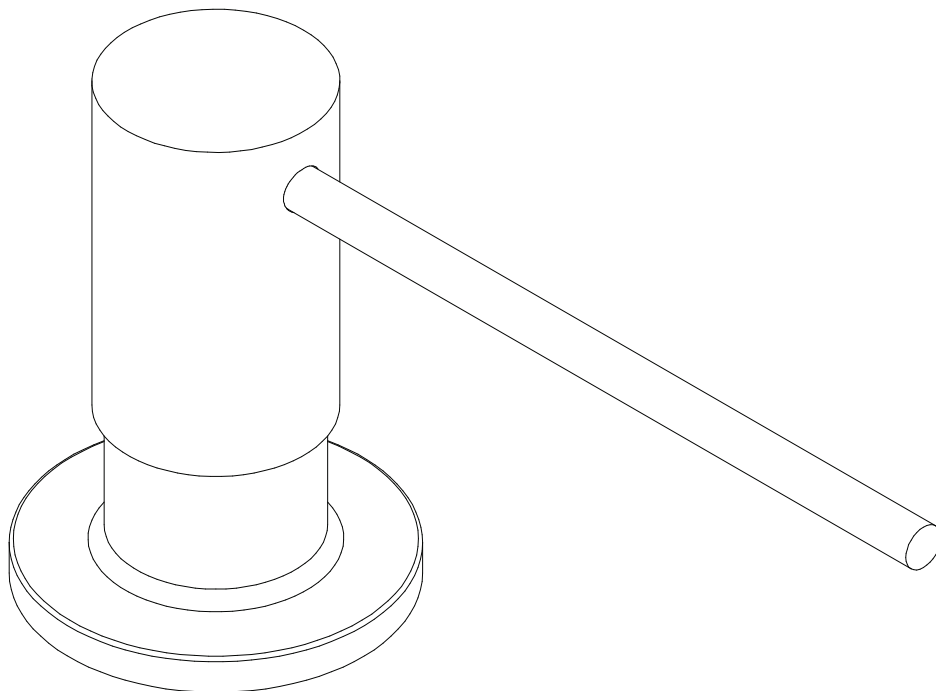

Required installation tools

Provided

Not Provided

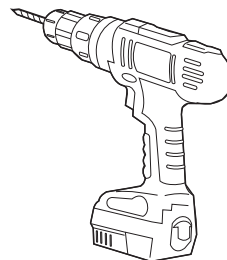

Power Drill



Ø 25 mm / 1"

Masonry Drill Bit

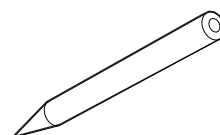

Marker

FV457/K3 - K5

Soap dispenser
Dispenser de jabón.

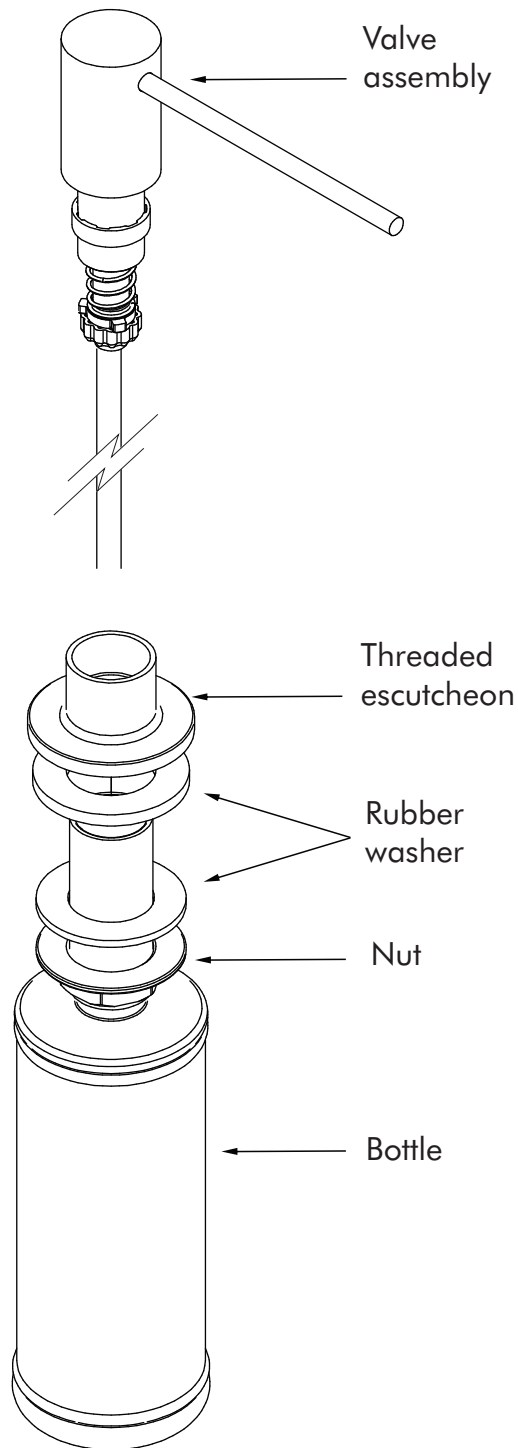

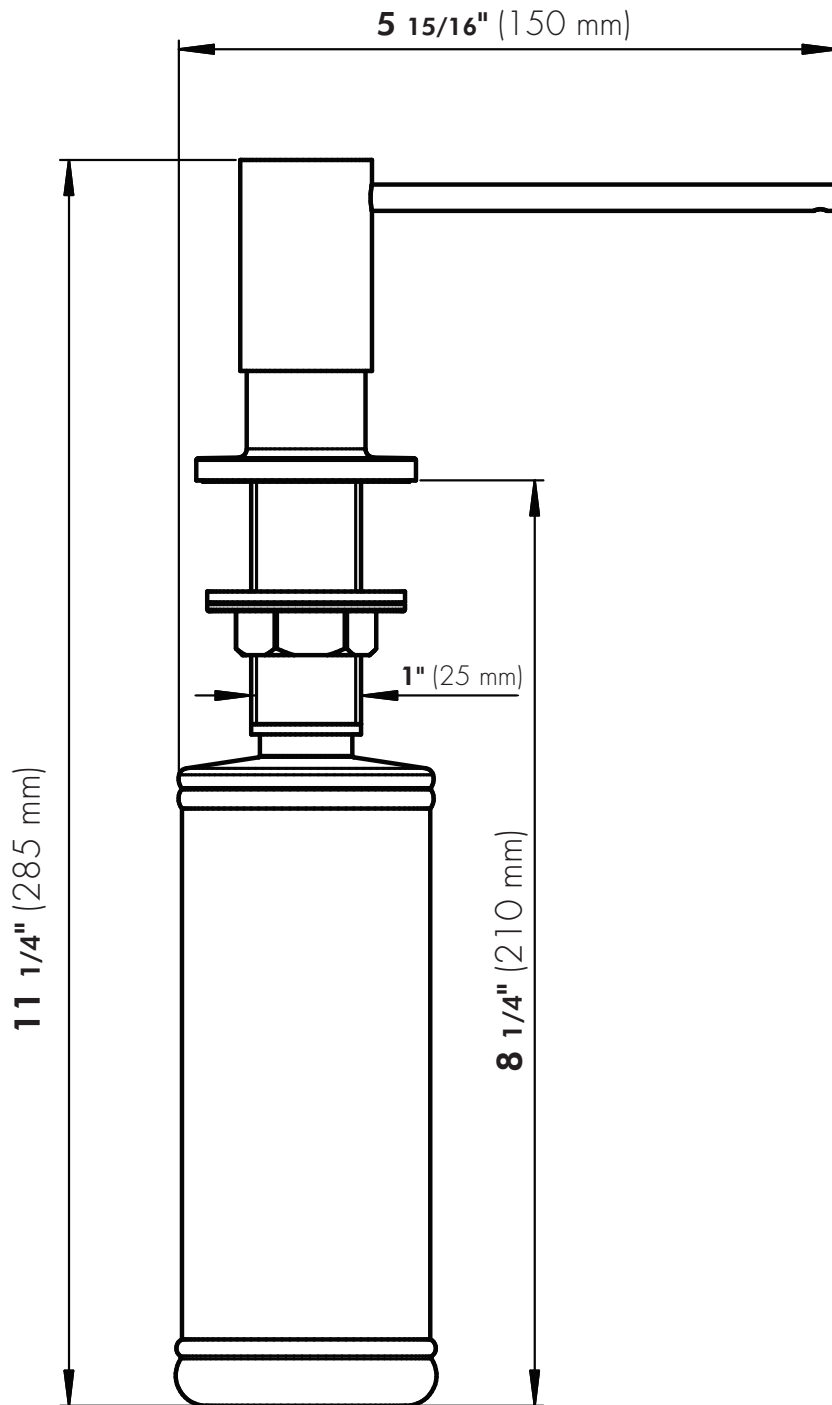

Installation/Instalación

Recommended deck hole size Min 1" (25mm) / Max 1 9/16" (40mm)

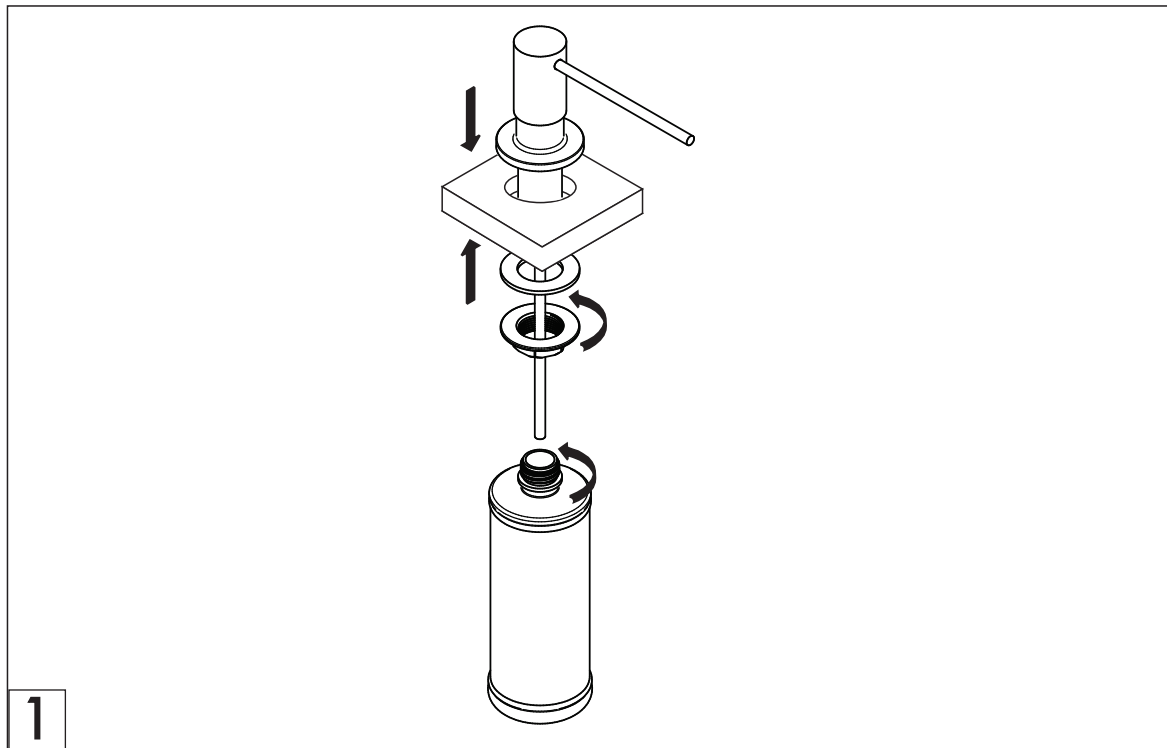

Finished installation.

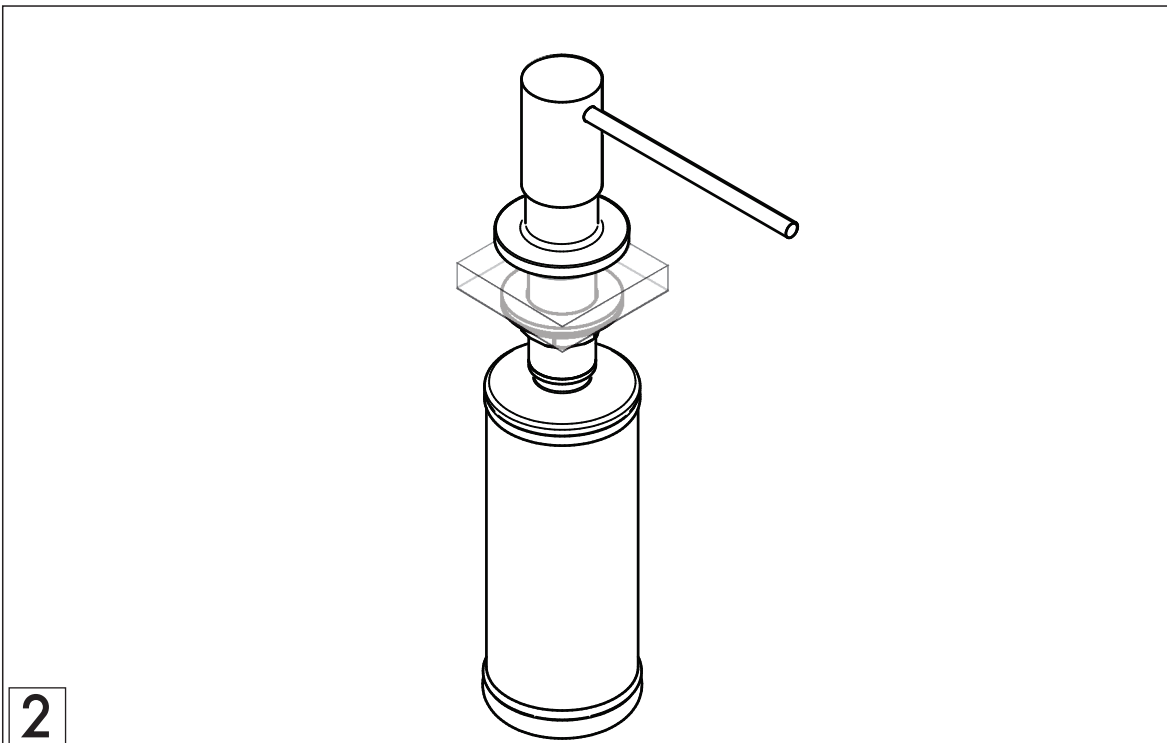

Refill/Rellenado

In order to refill, pull valve assembly.

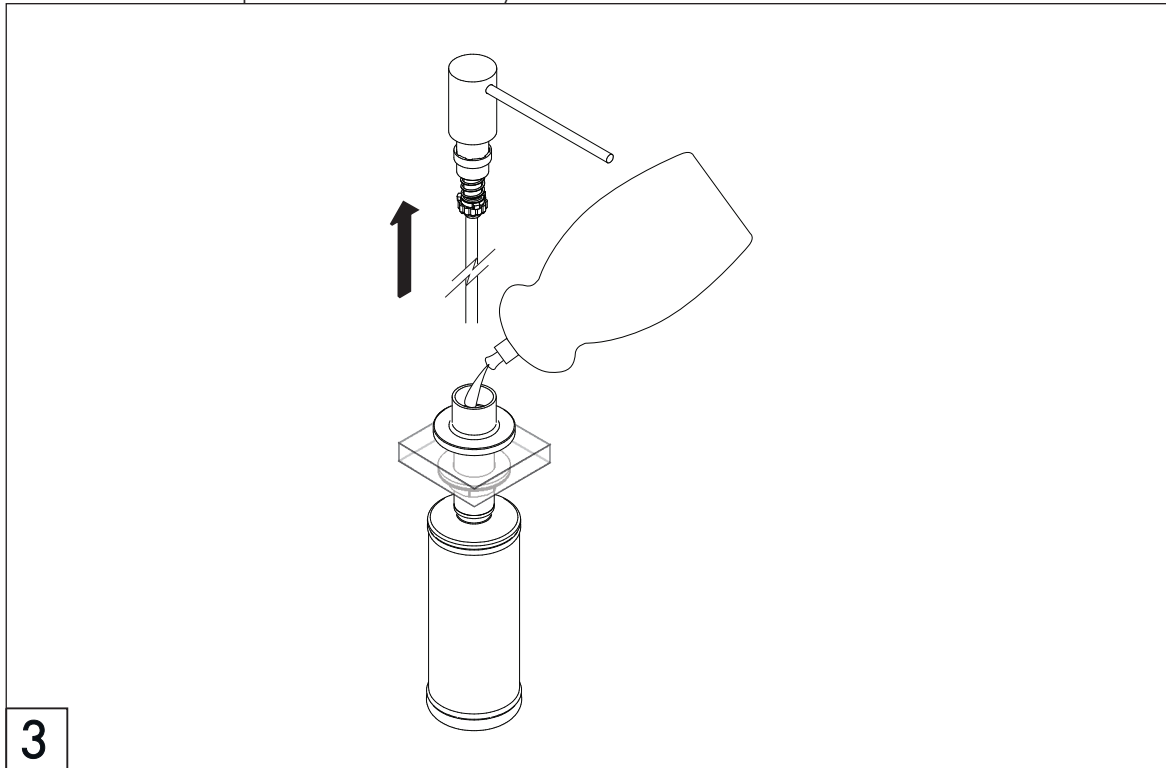

PRODUCT WARRANTY

Franz Viegener's Limited Lifetime Warranty insures that their products are free from defects in material and workmanship. This warranty is provided only to the original consumer/purchaser for the duration of home ownership.

Excluded from this warranty are parts made of wood or other non-metallic material, and all drain assembly finishes. Oil rubbed bronze, matte white and matte black have 2 years limited warranty from the date of purchase.

Any damage due to improper installation, abuse, misuse or accident will void this warranty.

Cleaning faucets with abrasive or chemical cleaners will void the finish warranty.

Warranty will be honored to original consumer/purchaser with proof of purchase/dated receipt.

If a defect is found under normal residential installation, we will, at our discretion either repair, provide a replacement part, replace the entire product, or make the appropriate adjustment.

Franz Viegener is not responsible for labor charges, installation, or other consequential costs. In no event shall the responsibility of Franz Viegener exceed the purchase price of the product.

Non-Residential Warranty - limited to 3 years for material and workmanship, 1 year warranty on oil rubbed bronze, matte black and matte white finishes. With proper care, your Franz Viegener product will keep its attractive appearance for many years. To assure the product continues to look its best, we recommend using the following care and cleaning procedures.

All finishes should be cleaned regularly with a clean, soft, damp cloth to remove water spots. This will keep mineral deposits from building up on the surface. Do not use abrasive cleaners, scouring pads, or cleaners containing ammonia or bleach.

CHROME FINISH - never use products containing chloride acid.

PVD FINISHES - never use Scotch Brand type scouring pads, nor products containing chloride acid.

POWDER COAT FINISHES - never use abrasives, alcohol, ether or ammonia products.

IMPLIED WARRANTIES, INCLUDING THOSE OF MERCHANTABILITY AND FITNESS FOR A PARTICULAR USE, ARE EXPRESSLY LIMITED IN DURATION TO THE DURATION OF WARRANTY. FRANZ VIEGENER AND/OR RESELLER DISCLAIMS ANY RESPONSIBILITY FOR SPECIAL, INCIDENTAL OR CONSEQUENTIAL DAMAGES.

Certificado de Garantía

La garantía de Fv ampara todos sus productos contra defectos de fabricación

Limpieza y mantenimiento

Los productos de FV han sido fabricados según técnicas de avanzada y con materiales de primera calidad,

que le aseguran una prolongada duración en perfectas condiciones.

A efectos de preservar esta calidad le sugerimos tener en cuenta estos consejos:

NO USE limpiadores abrasivos, polvo de limpieza, esponjas metálicas o de fibra.

USE en lo posible jabón neutro o detergente de uso doméstico. Seque con paño suave.

Condiciones de validez

Si a criterio debidamente fundado de personal técnico de FV se comprobara la intervención de mano de obra inexperta en la colocación, reparación y/o mantenimiento de los productos, esta garantía perderá automáticamente su validez. Asimismo será requisito inexcusable para realizar cualquier reclamo de garantía la presentación de la factura de compra original.

- 1) El fabricante y/o importador de este producto es FV S.A., una sociedad constituida y regulada por las leyes de la Republica Argentina, con planta en Villa Rosa (Prov. Bs. As.) y sede social en Reconquista 336 11° piso - Capital Federal.
- 2) La identificación del producto y las especificaciones técnicas necesarias constan consignadas en catálogo, folletería y en oficina técnica.
- 3) Ver condiciones de uso, mantenimiento y validez de la garantía en el texto que precede.
- 4) La reparación de los productos fabricados por FV sólo podrá delegarse en personal capacitado en caso de duda comunicarse a los centros de atención al usuario.
- 5) Plazo de garantía: 5 años.



FRANZ VIEGENER Customer Service Department (800) 446-9700

Phone 847-244-3837 / Fax 847-249-4049 - info@franzviegenger.com

4000 Porett Drive - Gurnee, IL, 60031-USA.

Follow us on social media!



Scan the code to get more information about this line.

www.franzviegenger.us